

## Pressure Monitor

with one high / low alarm output



**Application examples:** Extreme cold weather regions



Hot and sandy deserts



Red flashing LED backlight in case of a pressure alarm.

The F-Series is your first and safest choice for field mount indicators in safe and hazardous area applications. Especially in harsh weather conditions like rain, snow, salty atmospheres and temperatures between  $-40^{\circ}\text{C}$  up to  $+80^{\circ}\text{C}$  ( $-40^{\circ}\text{F}$  up to  $176^{\circ}\text{F}$ ).

### Advantages

- Robust IP67 (NEMA Type4X) field enclosure. It is so rugged, you can even stand on it!
- Intrinsically Safe available - ATEX, IECEx, FM and CSA approval for gas and dust applications.
- Programming can be done by your own crew, with the sensible menu-driven structure, saving cost and irritation. Know one, know them all!
- Very diverse mounting possibilities: walls, pipes, panels or directly onto outdoor sensors!

### Features

- Displays actual pressure and alarm values.
- Two alarm values can be entered: low and high pressure alarm.
- Large 17mm (0.67") digits.
- Red flashing LED backlight in case of a pressure alarm.
- Selectable on-screen engineering units: mBar - Bar - PSI.
- Pressure input signals: (0)4 - 20mA.
- One free configurable alarm output.
- Loop or battery powered, 8 - 24V DC or 115 - 230V AC power supply.
- Sensor supply 8.2 / 12 / 24V DC.
- Auto backup of all settings.
- Explosion/flame proof available.

## Introduction

The F053 is a versatile pressure indicator with continuous pressure monitoring feature. It offers the facility to set one low pressure and one high pressure alarm value. If desired, an ignore function can be set up to allow for an incorrect pressure for a certain period of time. A wide selection of options further enhances the capabilities of this model, including Intrinsic Safety.

## Display

The display has large 17mm (0.67") and 8mm (0.31") digits which displays the pressure, measuring unit and alarm values. As the F053 has been designed for field mounted applications, a smart display update function has been incorporated. Related to the lower temperature, the update frequency of the LCD is tuned automatically to achieve a readable display even at -40°C / -40°F.

## Configuration

All configuration settings are accessed via a simple operator menu which can be password protected. Each setting is clearly indicated with an alphanumerical description, which avoids - confusing abbreviations. All settings are safely stored in EEPROM memory in the event of sudden power failure.

## Hazardous areas

For hazardous area applications, this model is ATEX, IECEx, FM and CSA certified as Intrinsically Safe for gas and dust applications, with an allowed ambient temperature of -40°C to +70°C (-40°F to +158°F). A flame proof Ex d enclosure with ATEX certification is also available.



## Alarm output

One alarm output is available to transmit the pressure alarm. It can be set to switched for a low, high or both alarms! The output signal can be a passive NPN, active PNP or an isolated electromechanical relay.

## Backlight

The white backlight in combination with the F053 offers a unique feature: in case of a pressure alarm, the backlight can be set to be red or flashing red. The intensity can be adjusted from the keyboard. The display is a transfective type, which means that a high contrast reading is guaranteed in full sunlight as well as during the night. This backlight option is also available Intrinsically Safe.



All info at a glance



Easy to install



Easy to program



Know one know them all!



Reliable



User-friendly

## Overview application F053

The F-Series is your first and safest choice for field mount indicators in safe and hazardous area applications. Especially in harsh weather conditions like rain, snow, salty atmospheres and temperatures between -40°C up to +80°C (-40°F up to 176°F). For applications where continuous pressure measurement and monitoring is important. Alternative basic model: F050 or more advanced F190 or the D-Series DIN panel mount indicators.



## Signal input

The F053 accepts (0)4 - 20mA input signals from any type of pressure measurement device. Also a 4 - 20mA input loop powered model is available.

## Power requirements

Several power supply options are available to power the F053 and sensor. A battery powered version with a long life lithium battery which will last up to five years. A 4-20mA input loop powered version is available as well. A real sensor supply is offered with the 24V AC/DC or 115-230V AC power requirement options.



## Enclosures

Various types of enclosures can be selected, all ATEX and IECEx approved. The F053 is supplied in an GRP panel mount enclosure as standard, which can be converted to an IP67 / NEMA Type4X GRP field mount enclosure by the addition of a back case. Most popular is our rugged aluminum field mount enclosure with IP67 / NEMA Type4X rating. Both EU or U.S. cable gland entry threads are available.

## Dimensions enclosures

Aluminum & GRP panel mount enclosure

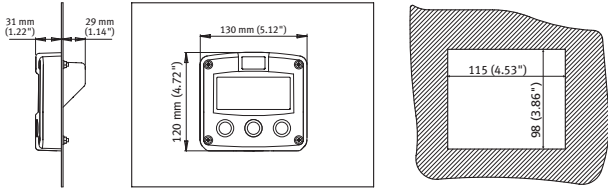

HB & HC enclosures

panel cut-out

Aluminum & GRP field / wall mount enclosures

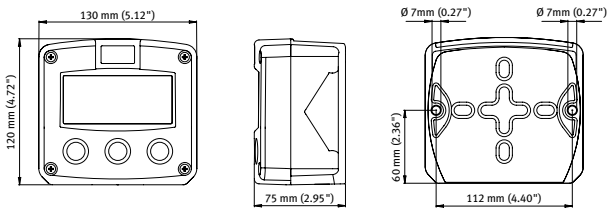

Aluminum

GRP

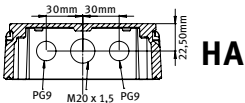

HA

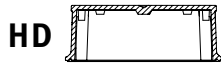

HD

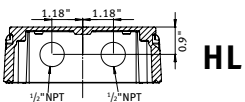

HL

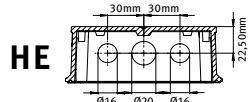

HE

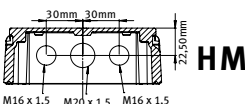

HM

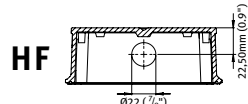

HF

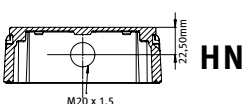

HN

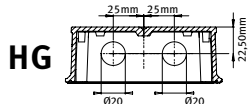

HG

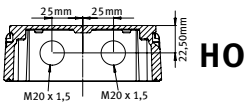

HO

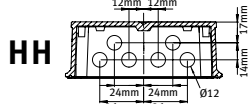

HH

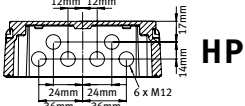

HP

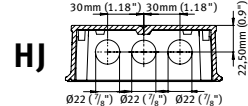

HJ

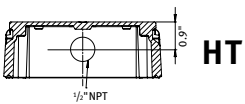

HT

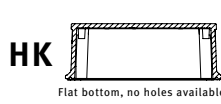

HK

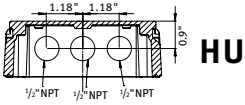

HU

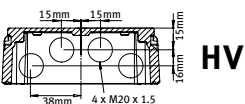

HV

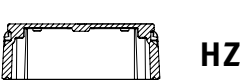

HZ

## Terminal connections

PB/PC - PD - PL - PX

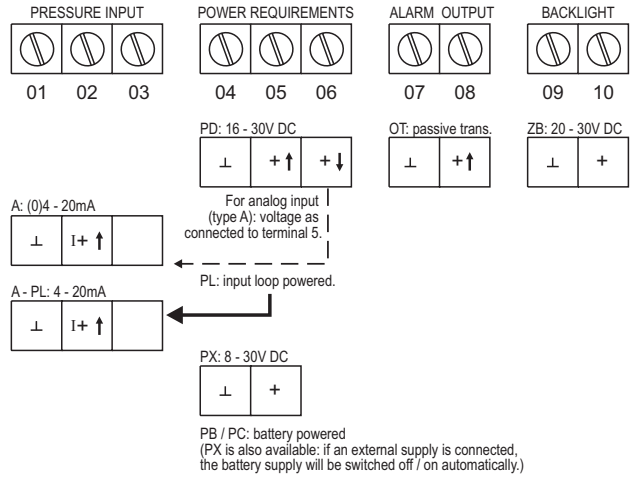

## Terminal connections

PF - PM

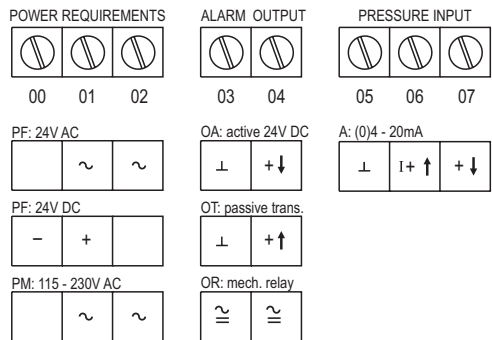

Configuration example F053-A-OT-PB-(PX)-XX-(ZB)

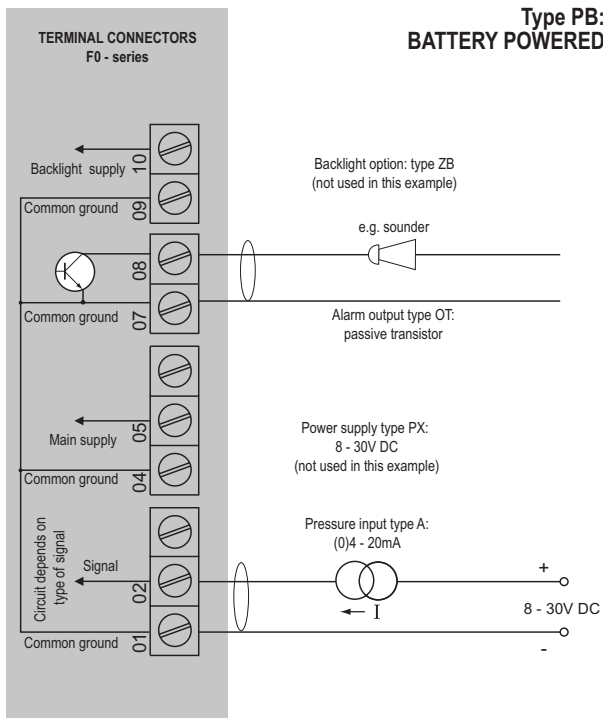

\* Sensor supply voltage: Terminal 3: not available.

Configuration example F053-A-(OT)-PL-XX-ZB

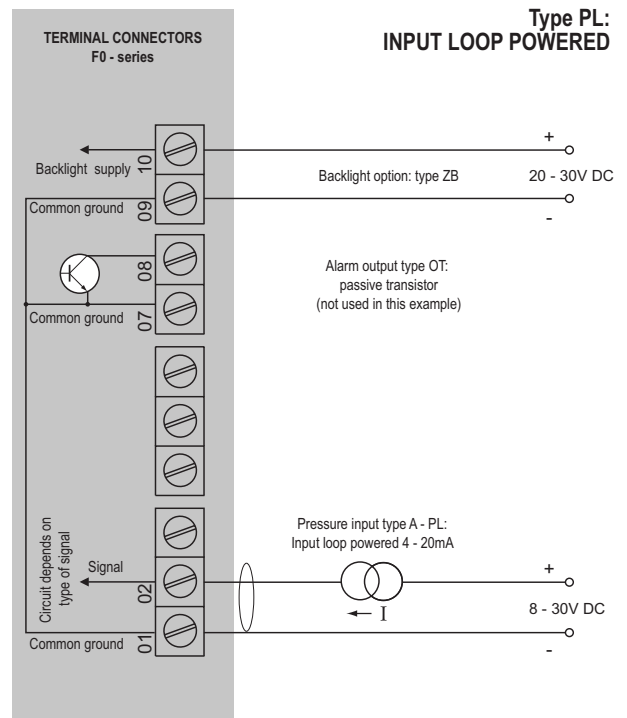

Sensor supply: sensor is externally powered.

Configuration example F053-A-OA-PF-XX-ZB

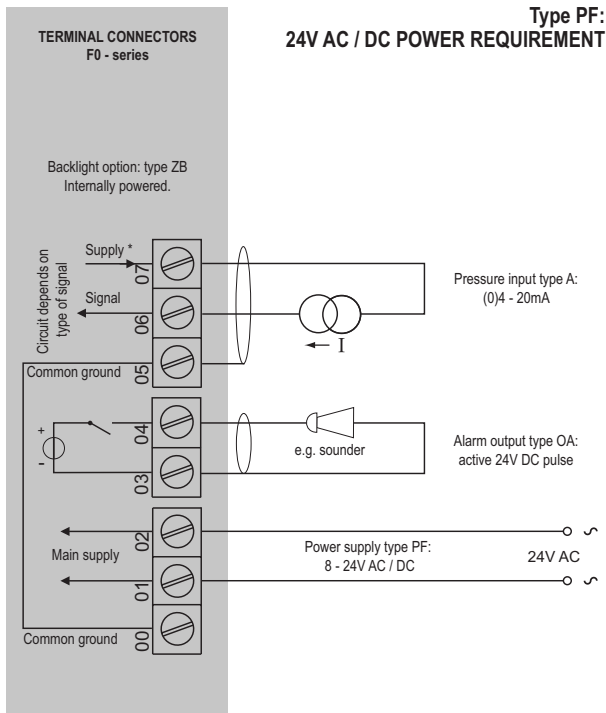

\* Sensor supply voltage: Terminal 7: 8.2 / 12 / 24V DC.

Configuration example F053-A-OR-PM-XX-ZB

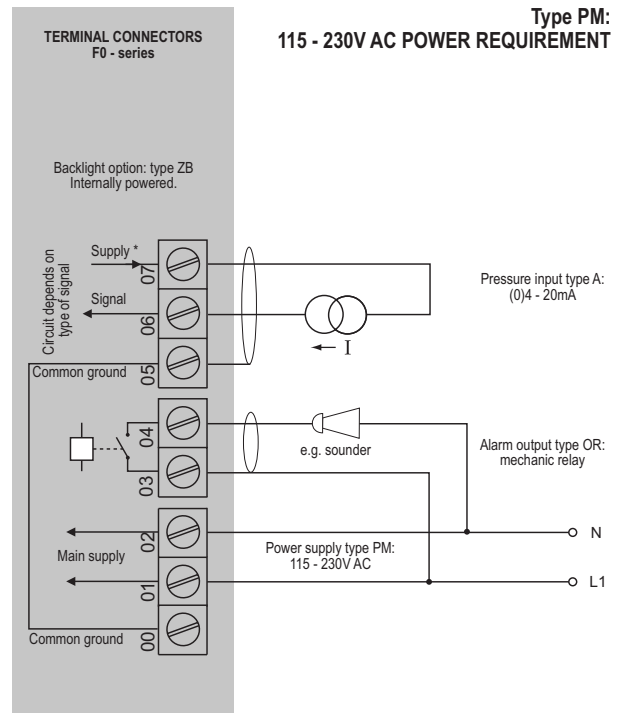

\* Sensor supply voltage: Terminal 7: 8.2 / 12 / 24V DC.

## Hazardous area applications

The F053-XI has been certified according to ATEX and IECEx by KEMA and according to CSA c-us and FM for use in Intrinsically Safe applications with an ambient temperature of -40°C to +70°C (-40°F to +158°F).

- The ATEX markings for gas and dust applications are:

Gas: **II 1 G Ex ia IIC T4 Ga.**

Dust: **II 1 D Ex ia IIIC T100 °C Da.**

- The IECEx markings for gas and dust applications are:

Gas: **Ex ia IIC T4 Ga**

Dust: **Ex ia IIIC T100 °C Da.**

- The CSA c-us markings are:

**IS Class I/II/III, Division 1, Groups A to G T4.**

**Class 1 Zone 0 AEx ia IIC T4 Ga.**

**Ex ia IIC T4 Ga.**

- The FM markings are:

**IS, Class I, II, III, Division 1, Groups A to G T4.**

**Class I, Zone 0, AEx ia IIC T4**

It is allowed to connect up to three I.S. power supplies to power the unit, sensor and backlight. Consult the certificate for the maximum input and output values of the circuits.

The F053-PD-XI offers the input voltage to power an analog sensor. An ATEX approved flame proof Ex d enclosure is available as well. Please contact your supplier for further details.

*Certificate of conformity KEMA 05ATEX1168 X*

• *IECEx KEM 08.0006X* • *CSA.08.2059461 X*

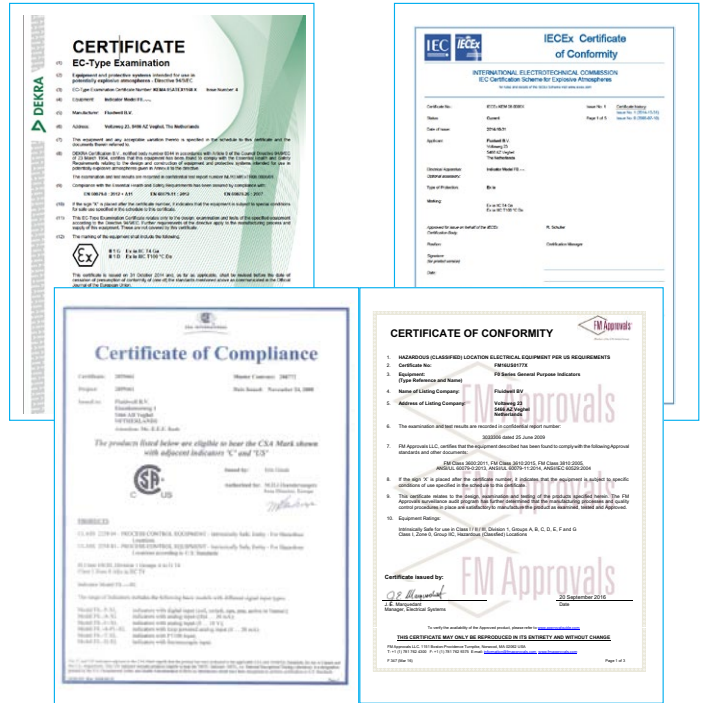

*Configuration example IIA - IIB and IIC - F053-A-OT-PX-XI-ZB - Basic power requirement 8 - 30V DC*

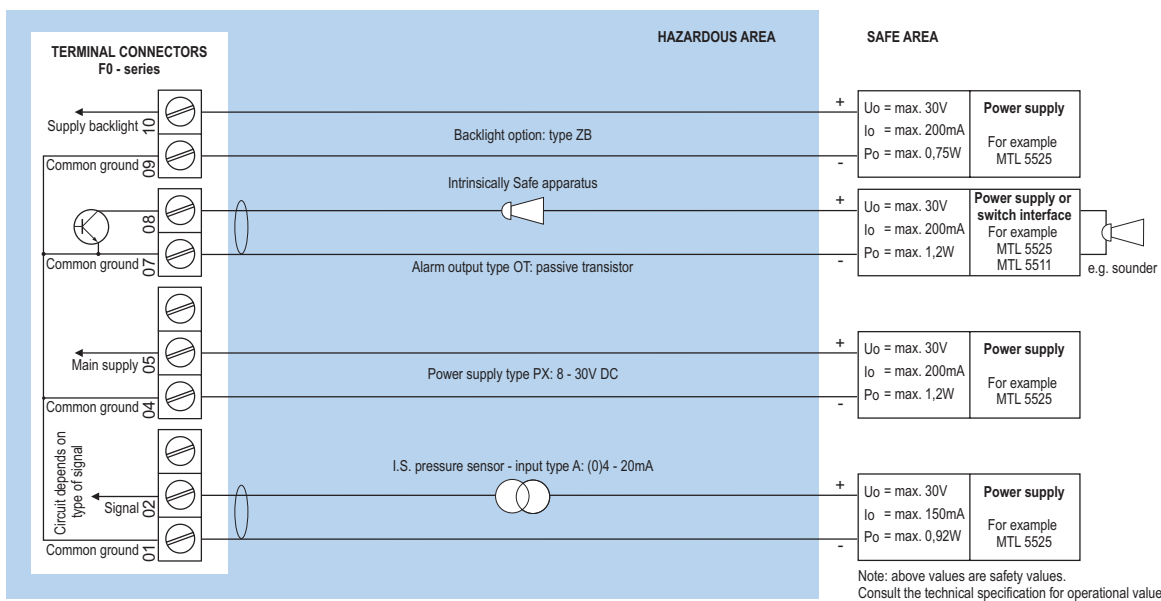

\* Sensor supply voltage for analog pressure sensor type A: not available in this example. Please note: type PX may be used in combination with the battery (type PC). PX will power the unit; the battery will be disabled automatically till power is disconnected.

## Configuration example IIA - IIB and IIC - F053-A-OT-PD-XI-ZB - Power requirement 16 - 30V DC

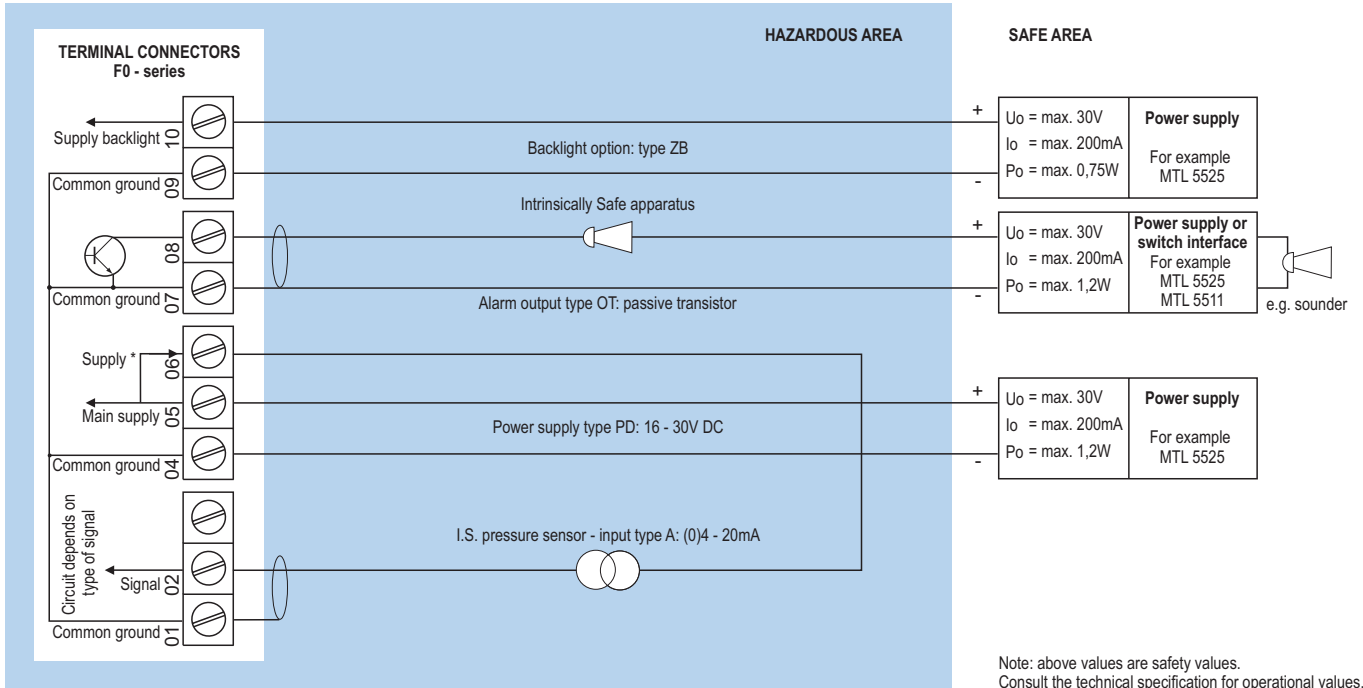

\* Sensor supply voltage for analog pressure sensor type A: Terminal 6: as input voltage terminal 5 (internally linked).  
Please note: type PD may be used in combination with the battery (type PC). PD will power the unit; the battery will be disabled automatically till power is disconnected.

## Configuration example IIA - IIB and IIC - F053-A-OT-PL-XI-ZB - Input loop powered

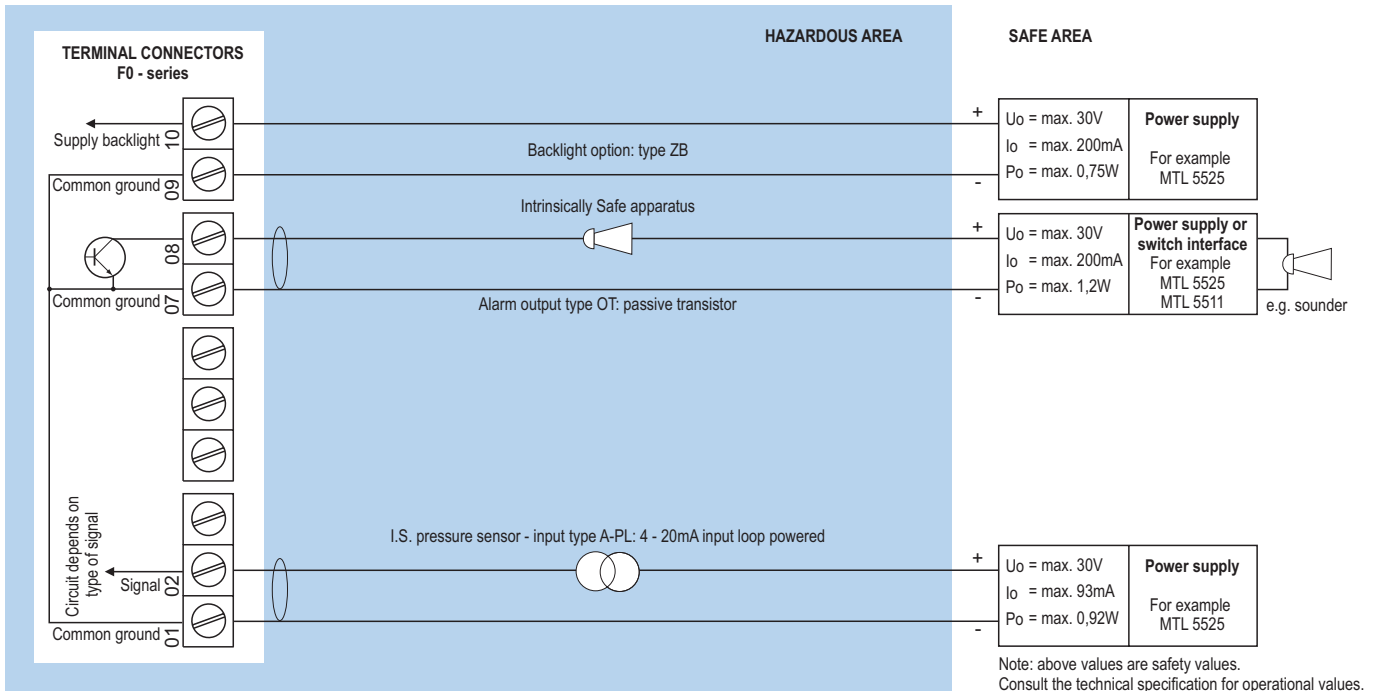

Sensor supply is not available: unit is input loop powered (type PL).  
Please note: type PL may be used in combination with the battery (type PC). PL will power the unit; the battery will be disabled automatically till power is disconnected.

## Display

<b>Type</b>	High intensity reflective numeric and alphanumeric LCD, UV-resistant.
<b>Dimensions</b>	90 x 40mm (3.5" x 1.6").
<b>Digits</b>	Seven 17mm (0.67") and eleven 8mm (0.31") digits. Various symbols and measuring units.
<b>Refresh rate</b>	User definable: fast, 1sec, 3sec, 15sec, 30sec, off.
<b>Option ZB</b>	Transflective LCD with white LED-backlight. Red (flashing) backlight during alarm conditions. Intensity and alarm response selected through the keyboard. Good readings in full sunlight and darkness. Also available Intrinsically Safe.

## Ambient temperature

<b>Safe areas</b>	-40°C to +80°C (-40°F to +176°F).
<b>Intrinsically Safe</b>	-40°C to +70°C (-40°F to +158°F).

## Power requirements

<b>Type PB</b>	Long life Lithium battery - life-time depends upon settings and configuration - up to 5 years. (requires PD, PL or PX)
<b>Type PC</b>	Intrinsically Safe long life lithium battery - life-time depends upon settings and configuration - up to 5 years. (requires XI and PD, PL or PX)
<b>Type PD</b>	16 - 30V DC. power consumption max. 1W.
<b>Type PF</b>	24V AC / DC ± 10%. Power consumption max. 15W.
<b>Type PL</b>	Input loop powered from sensor signal 4 - 20mA (type "A").
<b>Type PM</b>	115 - 230V AC ± 10%. Power consumption max. 15W.
<b>Type PX</b>	8 - 30V DC. Power consumption max. 0.3W.
<b>Type ZB</b>	20 - 30V DC ± 10%. Power consumption max. 1W. With type PF / PM: internally powered.
<b>Note PB/PF/PM</b>	Not available Intrinsically Safe.
<b>Note PF/PM</b>	The total consumption of the sensor, active output type OA and backlight type ZB may not exceed 400mA @ 24V DC.
<b>Note XI</b>	For Intrinsically Safe applications, consult the safety values in the certificate.

## Sensor excitation

<b>Type PB/PC/PX</b>	Not available.
<b>Type PD</b>	The sensor supply voltage will be according to power supply voltage (as connected to terminal 5).
<b>Type PF / PM</b>	8.2 / 12 / 24V DC - max. 400mA @ 24V DC.

## Terminal connections

<b>Type</b>	Removable plug-in terminal strip. Wire max. 1.5mm <sup>2</sup> and 2.5mm <sup>2</sup> .
-------------	---

## Data protection

<b>Type</b>	EEPROM backup of all settings. Data retention at least 10 years.
<b>Password</b>	Configuration settings can be password protected.

## Directives & Standards

<b>EMC</b>	Directive 2014/30/EU, FCC 47 CFR part 15.
<b>Low voltage</b>	Directive 2014/35/EU
<b>RoHS</b>	Directive 2011/65/EU
<b>ATEX / IECEx</b>	Directive 2014/34/EU, IEC 600079-0, IEC 60079-11. IP & NEMA EN 60529 & NEMA 250
<b>FM</b>	FM Class No. 3600, FM Class No. 3610.
<b>CSA</b>	CSA 22.2 No. 157-92.
<b>IP &amp; NEMA</b>	EN 60529 & NEMA 250.

## Enclosure

<b>Window</b>	Polycarbonate window.
<b>Sealing</b>	Silicone.
<b>Control keys</b>	Three industrial micro-switch keys. UV-resistant silicone keypad.

## Aluminum wall / field mount enclosures

<b>General</b>	Die-cast aluminum wall/field mount enclosure IP67 / NEMA Type4X with 2-component UV-resistant coating.
<b>Dimensions</b>	130 x 120 x 75mm (5.12" x 4.72" x 2.95") - W x H x D.
<b>Weight</b>	1100 gr.
<b>Type HA</b>	Cable entry: 2 x PG9 and 1 x M20.
<b>Type HL</b>	Cable entry: 2 x 1/2 NPT.
<b>Type HM</b>	Cable entry: 2 x M16 and 1 x M20.
<b>Type HN</b>	Cable entry: 1 x M20.
<b>Type HO</b>	Cable entry: 2 x M20.
<b>Type HP</b>	Cable entry: 6 x M12.
<b>Type HT</b>	Cable entry: 1 x 1/2" NPT.
<b>Type HU</b>	Cable entry: 3 x 1/2" NPT.
<b>Type HV</b>	Cable entry: 4 x M20.
<b>Type HZ</b>	Cable entry: no holes.

## GRP wall / field mount enclosures

<b>General</b>	GRP wall/field mount enclosure IP67 / NEMA Type4X, UV-resistant and flame retardant.
<b>Dimensions</b>	130 x 120 x 75mm (5.12" x 4.72" x 2.95") - W x H x D.
<b>Weight</b>	600 gr.
<b>Type HD</b>	Cable entry: no holes.
<b>Type HE</b>	Cable entry: 2 x Ø 16mm and 1 x Ø 20mm.
<b>Type HF</b>	Cable entry: 1 x Ø 22mm (7/8").
<b>Type HG</b>	Cable entry: 2 x Ø 20mm.
<b>Type HH</b>	Cable entry: 6 x Ø 12mm.
<b>Type HJ</b>	Cable entry: 3 x Ø 22mm (7/8").
<b>Type HK</b>	Flat bottom, cable entry: no holes.

## Panel mount enclosures

<b>Dimensions</b>	130 x 120 x 60mm (5.12" x 4.72" x 2.36") - W x H x D.
<b>Panel cut-out</b>	115 x 98mm (4.53" x 3.86") L x H.
<b>Type HB</b>	Die-cast aluminum panel mount enclosure IP65 / NEMA Type4X.
<b>Weight</b>	600 gr.
<b>Type HC</b>	GRP panel mount enclosure IP65 / NEMA Type4X, UV-resistant and flame retardant.
<b>Weight</b>	450 gr.



## Intrinsically Safe (Type XI)

<b>ATEX</b>	Gas: II 1 G Ex ia IIC T4 Ga. Dust: II 1 D Ex ia IIIC T100 °C Da.
<b>IECEX</b>	Gas: Ex ia IIC T4 Ga. Dust: Ex ia IIIC T100 °C Da.
<b>CSA c-us</b>	IS Class I/II/III, Division 1, Groups A to G T4. Class 1 Zone 0 AEx ia IIC T4 Ga. Ex ia IIC T4 Ga.
<b>FM</b>	IS, Class I, II, III, Division 1, Groups A to G T4. Class I, Zone 0, AEx ia IIC T4
<b>Ambient Ta</b>	-40°C to +70°C (-40°F to +158°F).

## Explosion proof (Type XF)

<b>ATEX</b>	II 2 G / Ex d IIB T5 Gb. II 2 D / Ex t IIIB T100 °C Db.
<b>Type XF</b>	Dimensions of enclosure: 300 x 250 x 200mm (11.8" x 9.9" x 7.9") L x H x D.
<b>Weight</b>	Appr. 15kg.
<b>Note XF</b>	IECEX available on request.

## Signal inputs - Pressure

<b>Type A</b>	(0)4 - 20mA. Analog input signal can be scaled to any desired range within 0 - 20mA.
<b>Type U</b>	0 - 10V DC. Contact factory.
<b>Accuracy</b>	Resolution: 16 bit. Error < 0.01mA / ± 0.05% FS. Low level cut-off programmable.
<b>Span</b>	0.001 - 999,999 with variable decimal position.
<b>Offset</b>	-999,999 / +999,999 units.
<b>Update time</b>	Four times per second.
<b>Voltage drop</b>	Type A: max. 1V DC @ 20mA.
<b>Voltage drop</b>	Type A - PL (loop powered): max. 2.6V DC @ 20mA.
<b>Relationship</b>	Linear and square root calculation.
<b>Note A</b>	For signal type A: external power to sensor is required; e.g. type PD.

## Signal output - Digital output

<b>Function</b>	User defined: low, high or both alarms output.
<b>Type OA</b>	One active 24V DC transistor output (PNP); load max. 400mA (requires PF or PM).
<b>Type OR</b>	One electro-mechanical relay output - isolated; max. switch power 230V AC (N.O.) - 0.5A (requires PF or PM).
<b>Type OT</b>	One passive transistor output (NPN) - not isolated. Max. 50V DC - 300mA per output.

## Operator functions

<b>Displayed info</b>	<ul style="list-style-type: none"> <li>Actual pressure.</li> <li>Low alarm value.</li> <li>High alarm value.</li> <li>Alarm values can be set (or only displayed).</li> </ul>
-----------------------	---

## Pressure

<b>Digits</b>	7 digits.
<b>Units</b>	mbar, bar, PSI, no-unit.
<b>Decimals</b>	0 - 1 - 2 or 3.

## Alarm values

<b>Digits</b>	7 digits.
<b>Units</b>	According to selection for pressure.
<b>Decimals</b>	According to selection for pressure.
<b>Time units</b>	According to selection for pressure.
<b>Type of alarm</b>	Low and high pressure alarm. Includes alarm delay time and configurable alarm output.

## Mounting accessories

<b>ACF02</b>	Stainless steel wall mounting kit.
<b>ACF05</b>	Stainless steel pipe mounting kit (worm gear clamps not included).
<b>ACF06</b>	Two stainless steel worm gear clamps Ø 44 - 56mm.
<b>ACF07</b>	Two stainless steel worm gear clamps Ø 58 - 75mm.
<b>ACF08</b>	Two stainless steel worm gear clamps Ø 77 - 95mm.
<b>ACF09</b>	Two stainless steel worm gear clamps Ø 106 - 138mm.
<b>ACF11</b>	Swivel with 25° movement from center axis for direct flowmeter mounting: 1" NPT to 1/2" NPT.

## Intrinsically Safe isolators

<b>ACG01</b>	MTL5511 - One channel pulse or switch output transfer from hazardous area to safe area.
<b>ACG02</b>	MTL5525 - One channel power supply from safe area to hazardous area (e.g. to power the unit with PD or to power a switching or analog device in hazardous area).
<b>ACG03</b>	MTL5541 - One channel 4 - 20mA repeater from hazardous area to safe area.
<b>ACG04</b>	MTL 5051 - Bi-direction serial-data-isolator (for Modbus communication).
<b>ACG05</b>	MTL5516C - Two channel pulse or switch output transfer from hazardous area to safe area.
<b>ACG06</b>	MTL5513 - One channel pulse or switch output transfer from hazardous area to safe area.
<b>ACG07</b>	MTL5546Y - One channel isolated driver bringing 4 - 20mA from safe area to hazardous area, HART transparent, OCD.

		Description						
Model	<b>F053</b>	<b>Pressure monitor with one high / low alarm output.</b>						
Input	<b>A</b>	<b>(0)4 - 20mA input.</b>			<b>-A</b>			
Enclosures	HB	Aluminum panel mount enclosure.			-HB			
	<b>HC</b>	<b>GRP panel mount enclosure.</b>			<b>-HC</b>			
	HD	GRP field mount - Cable entry: no holes.			-HD			
	HE	GRP field mount - Cable entry: 2 x Ø 16mm & 1 x Ø 20mm.			-HE			
	HF	GRP field mount - Cable entry: 1 x Ø 22mm (7/8").			-HF			
	HG	GRP field mount - Cable entry: 2 x Ø 20mm.			-HG			
	HH	GRP field mount - Cable entry: 6 x Ø 12mm.			-HH			
	HJ	GRP field mount - Cable entry: 3 x Ø 22mm (7/8").			-HJ			
	HK	GRP field mount, flat bottom - Cable entry: no holes.			-HK			
	HA	Aluminum field mount - Cable entry: 2 x PG9 + 1 x M20.			-HA			
	HL	Aluminum field mount - Cable entry: 2 x 1/2"NPT.			-HL			
	HM	Aluminum field mount - Cable entry: 2 x M16 + 1 x M20.			-HM			
	HN	Aluminum field mount - Cable entry: 1 x M20.			-HN			
	HO	Aluminum field mount - Cable entry: 2 x M20.			-HO			
	HP	Aluminum field mount - Cable entry: 6 x M12.			-HP			
	HT	Aluminum field mount - Cable entry: 1 x 1/2"NPT.			-HT			
	HU	Aluminum field mount - Cable entry: 3 x 1/2"NPT.			-HU			
	HV	Aluminum field mount - Cable entry: 4 x M20.			-HV			
	HZ	Aluminum field mount - Cable entry: no holes.			-HZ			
Digital output	OA	One active transistor output - requires XX and PF or PM.			-OA			
	OR	One mechanical relay output - requires XX and PF or PM.			-OR			
	<b>OT</b>	<b>One passive transistor output.</b>			<b>-OT</b>			
Power	PD	16 - 30 V DC + sensor supply.			-PD			
	PF	24V AC/DC + sensor supply - requires XX.			-PF			
	PL	Input loop powered from sensor signal type "A".			-PL			
	PM	115 - 230V AC + sensor supply - requires XX.			-PM			
	<b>PX</b>	<b>Basic power supply 8 - 30V DC.</b>			<b>-PX</b>			
Battery	PB	Additional lithium battery powered (opt.) - requires XX and PD or PX.			-PB -P_			
	PC	Additional lithium battery powered (opt.) - Intrins. safe - requires XI and PD or PX.			-PC -P_			
Hazardous	XI	Intrinsically safe, according ATEX, IECEx, CSA c-us and FM.			-XI			
	XF	Ex d enclosure - 3 keys according ATEX.			-XF			
	<b>XX</b>	<b>Safe area only.</b>			<b>-XX</b>			
Options	ZB	Backlight.			-ZB			
	<b>ZX</b>	<b>No options.</b>			<b>-ZX</b>			
		F053	-A	-H_	-O_	-P_	-X_	-Z_

The **bold** marked text contains the standard configuration: F053-A-HC-OT-PX-XX-ZX.