



Energy Measurement

BEX3 Energy Meter



PRODUCT INTRODUCTION

The energy meter EX3 is specially designed for central air conditioning systems to do cooling and heating measurement. It could measure and charge for cooling and heating.

The energy consumed by the user is calculated by measuring the temperature and flow rate of the chilled water (or hot water) flowing through the pipe.

Install an energy meter EX3 on the user's inlet pipe and install a temperature sensor on each of the inlet and outlet pipes. The energy is calculated by metering the amount of chilled water (or hot water) flowing through the pipe (ie, the flow rate and pipe size), and the temperature difference between the incoming and return water.

Features

High-quality aluminum alloy case with good mechanical strength and beautiful appearance.

PT1000 high-precision temperature sensor with a precision measuring circuit to ensure high-precision temperature measurement.

Clamp on type, no need to cut or change the pipe;

No special knowledge is required. installation and measurement can be done according to the operating instructions.

No moving parts, no pressure loss, no need to stop production during the installation and measurement.



APPLICATION

The energy meter EX3 is widely used in central air conditioning, heating, power plants, paper and pulp, food and medicine, petroleum, chemical, metallurgy, mining, flow inspection, flow tracking and collection.

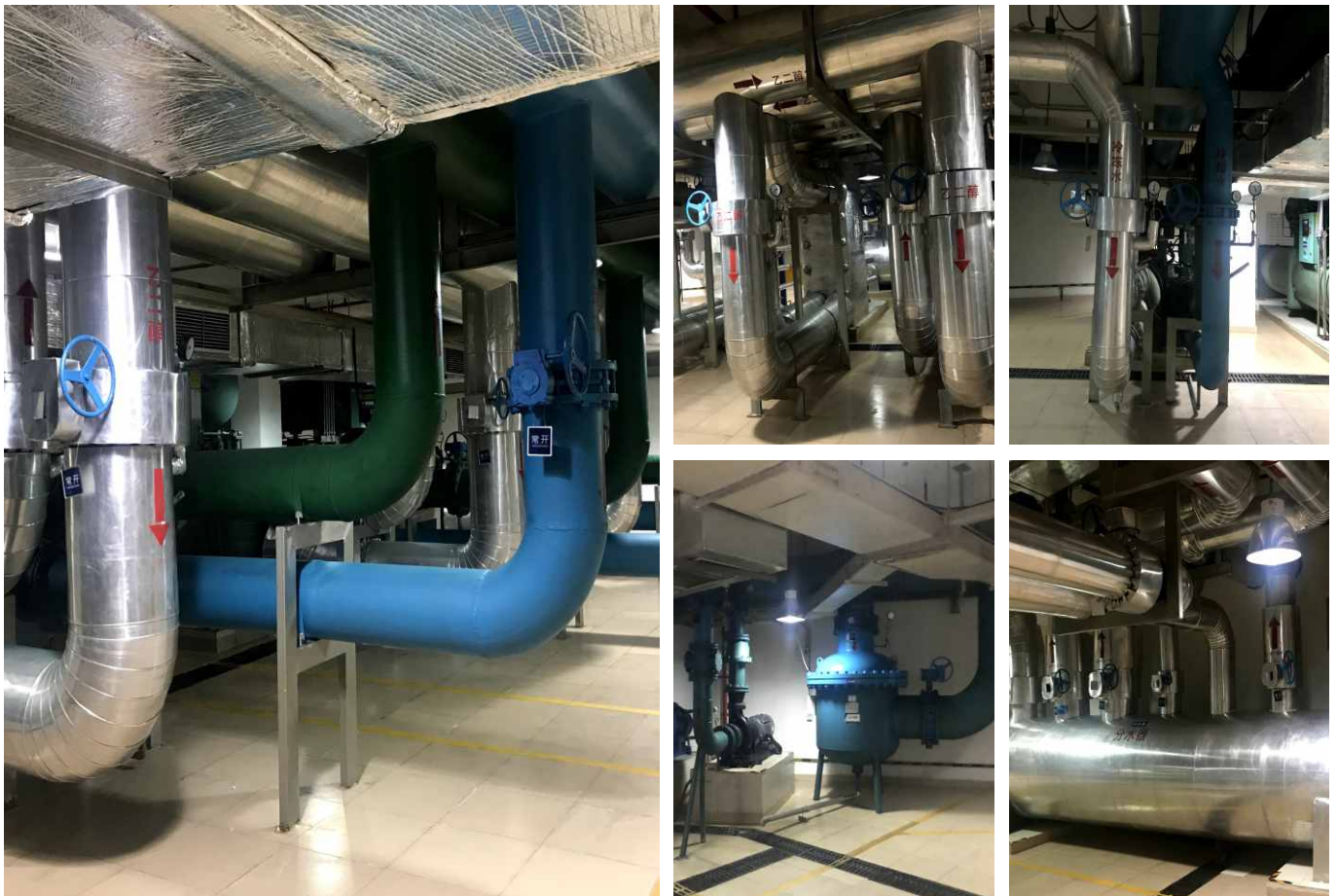

COMPONENT PARTS



ETM™



Temperature sensor



Connecting cable



Flow Transducer



Temp. Mount



Pipe Strap

PIPING SPECIFICATION

Model	EX3-DN15	EX3-DN20	EX3-DN25	EX3-DN32	EX3-DN40	EX3-DN50	EX3-DN65	EX3-DN80
Nominal pipe diameter DN	15mm	20mm	25mm	32mm	40mm	50mm	65mm	80mm
Pipe OD	20mm	25mm	32mm	40mm	50mm	63mm	75mm	90mm
Pipe ID	15mm	19mm	26mm	33mm	43mm	55mm	67mm	82mm
Wall thickness	2.5mm	3mm	3mm	3.5mm	3.5mm	4mm	4mm	4mm

INSTALLATION STEPS

01 Clean the pipe



No dirt, paint, or debris on the surface of the pipe.

02 Install the bracket



Install screw on the top part of the bracket, the bottom part of the bracket will automatically connect with the top part. Tighten the screws.

03 Install the flow transducer

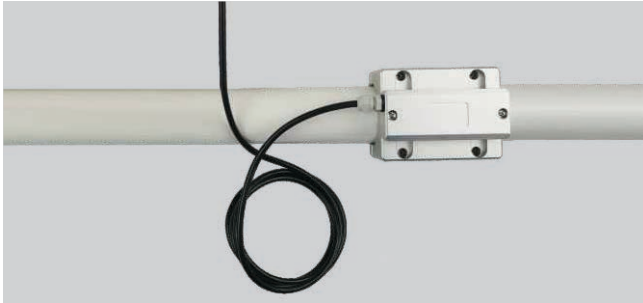

Install the flow transducer on the upper bracket and tighten the screws.

04 Install the temperature sensor

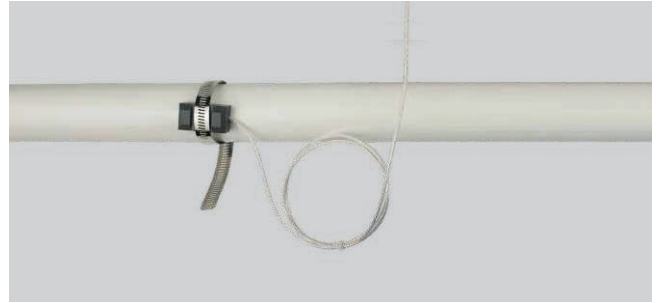

Fix the transducer sensor on the pipe with a Pipe Strap.

05 Run the Energy Meter

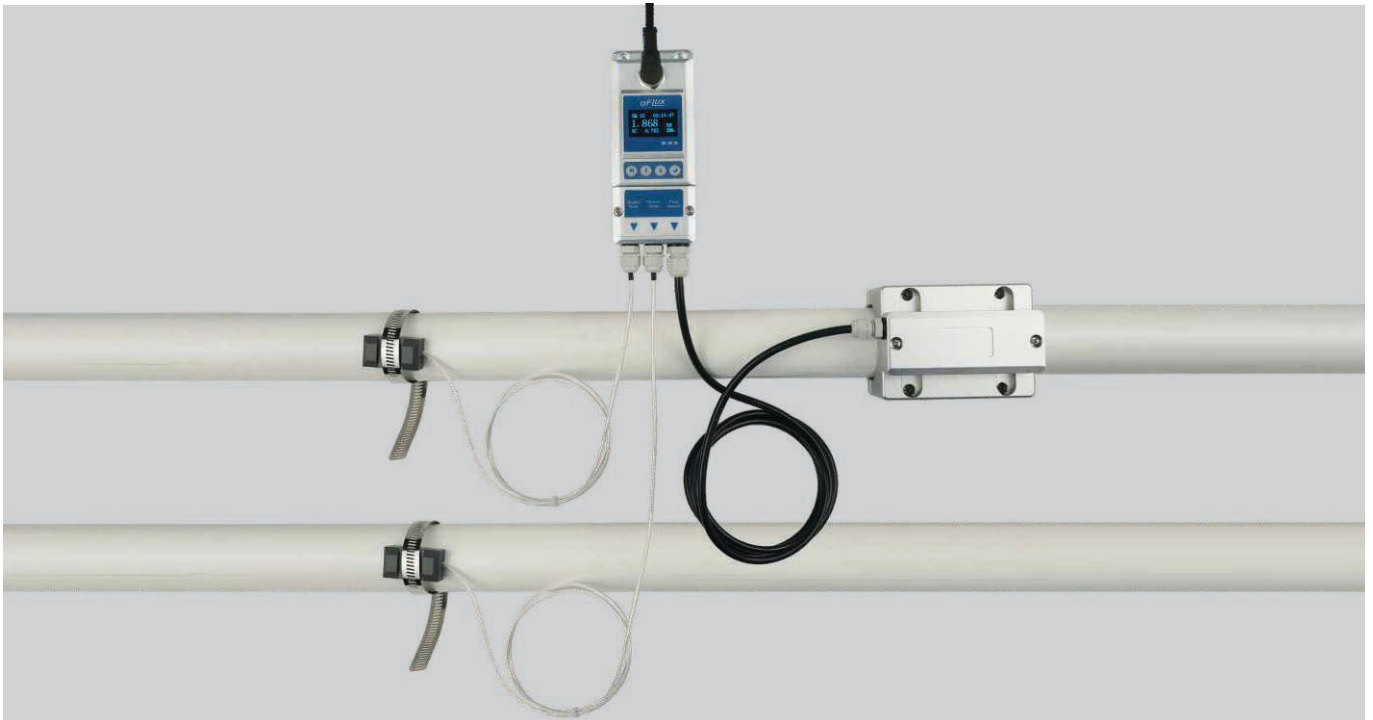

Please refer the manual for cable connection; Power on and see if the $SQ \geq 50$ which indicates that the measurement has been stable. Wrap the insulation layer and complete the installation.

ETM™ SETTING

Special instructions:

ETM™, which is designed for different pipe diameter and materials, will be set in standard setting before it leaves the factory. There is no need to reset.

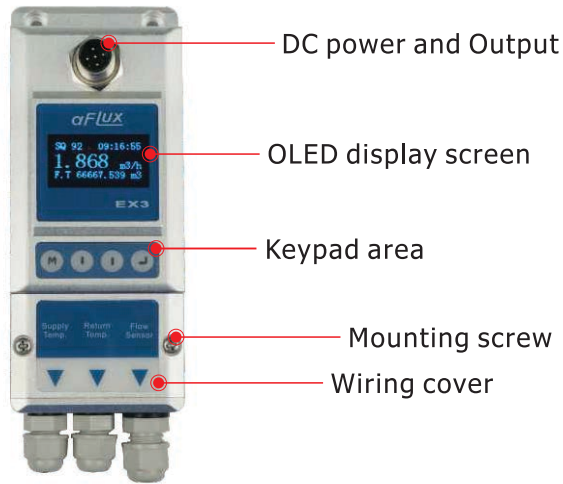

DISPLAY MENU

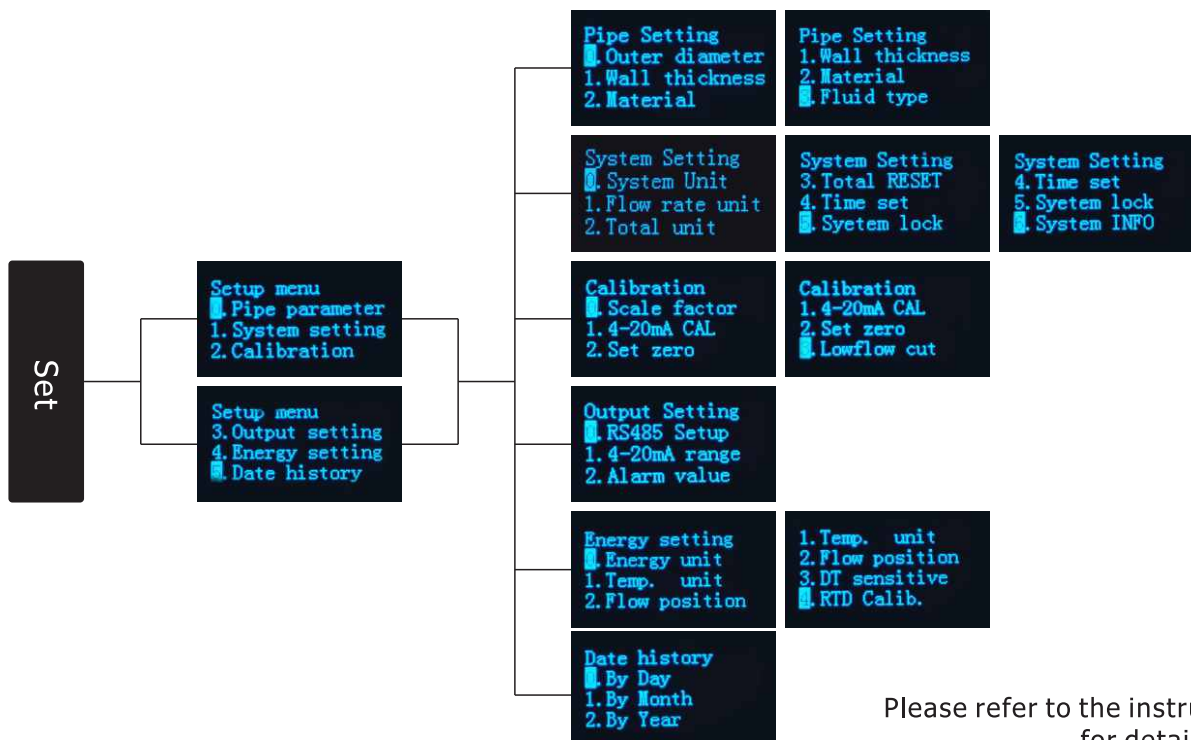

Please refer to the instruction manual for detailed operation.

PERFORMANCE INDEX

Product	EX3 Energy Meter 
Model	EX3
Flow range	0.1 m/s ~ 5.0 m/s
Accuracy	±2.0%
Repeatability	0.8%
Pipe size	DN15, DN20, DN25, DN32, DN40, DN50, DN65, DN80
Data storage	Daily, monthly, and Annual. Flow Totalizer
Alarm output	OCT, Upper and lower limit alarm function (optional)
Communication	RS485, (MODBUS or MeterBUS optional)
Power supply	24 VDC
Cable length	1.8m
Keypad	Four light touch buttons
Screen	OLED 128*64 display screen
Units	Metric and imperial units are available, Cubic Meters(m3), Liters(L), USA Gallons(GAL)/hour, /min, Default unit setting: m3/h
Totalizer	Six bit digit
Piper material	Stainless steel pipe, carbon steel pipe, PVC
Case material	Aluminum alloy
Environment temp.	0°C - 50°C
RTD measuring temp.	2°C -105°C
Medium temp.	0°C - 80°C
Environment humidity	0-95% relative humidity, without condensation
IP Grade	IP54

Weight (KG)	DN15	DN20	DN25	DN32	DN40	DN50	DN65	DN80
	0.76	0.78	0.81	0.86	0.90	0.91	0.94	1.0

DIMENSIONS

Model	A (mm)	B (mm)	C (mm)	D(mm)	
				min	max
EX3-DN15	25	8	58	1.5/φ20	8/φ23
EX3-DN20	25	15	58	1.5/φ25	4.5/φ28
EX3-DN25	28.5	18.5	58	1.5/φ32	4.5/φ35
EX3-DN32	29.5	24	68	1.5/φ38	8.5/φ45
EX3-DN40	36	27	78	1.5/φ48	7.5/φ54
EX3-DN50	41	32	91	1.5/φ58	7.5/φ64
EX3-DN65	44.5	35.5	102	1.5/φ65	11.5/φ75
EX3-DN80				1.5/φ76	11.5/φ86

Transmitter size

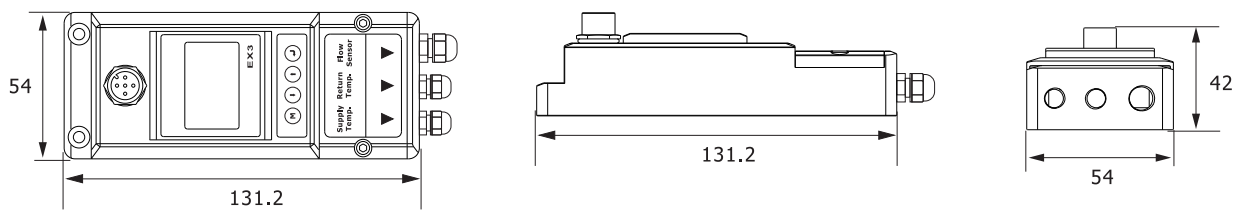

Flow Transducer size

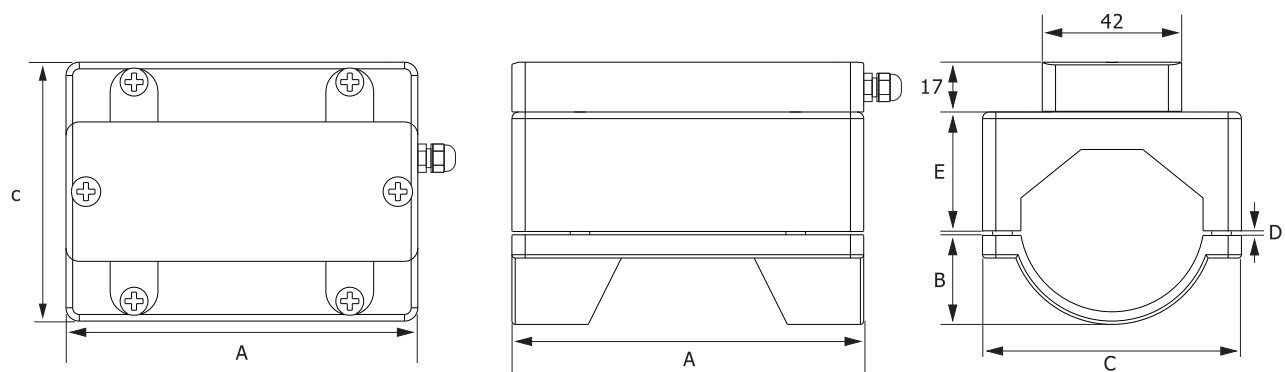

Temperature sensor size

